

GRAPHITE

ENERGY+
system

3
YEARS
WARRANTY



2020

GRAPHITE

ENERGY+
system



A Graphite márka jellemzői:

- ▶ kimagasló minőségű, intenzív az ipari mértékhez közeli terhelésű használatra tervezett, elektromos szerszámok
- ▶ kítűnő tulajdonságokkal rendelkező termékek: tartósság, erős motor, ergonomikus tervezés
- ▶ szavatolja az eredményes munkavégzést és hogy megfelelően fekteti be a pénzét ha ezeket a termékeket választja
- ▶ alkatrészek és kiegészítők teljes szortimentje

GRAPHITE înseamnă:

- ▶ un sortiment variat de scule electrice de înaltă calitate, proiectat pentru utilizare intensivă, cu sarcini apropiate de cele profesionale
- ▶ produse cu un set optim de caracteristici: rezistent, motoare durabile, proiectate ergonomic
- ▶ garantarea realizării efectului dorit legat de munca bine realizată, și investiția corectă a banilor
- ▶ disponibilitatea completă a pieselor de schimb și a materialelor de exploatare

GRAPHITE è sinonimo di:

- ▶ una vasta gamma di elettrotensili di alta qualità destinati ad impieghi pesanti, con carichi prossimi a quelli caratteristici dell'utilizzo professionale
- ▶ prodotti con un set di caratteristiche ottimali: durevoli, con motori potenti, dal design ergonomico
- ▶ garanzia di raggiungimento dell'effetto desiderato, di un lavoro ben svolto e soldi ben investiti
- ▶ piena disponibilità di ricambi e materiali di consumo

EGY akkumulátor
SZÁMOS lehetőség

UN acumulator
MAI MULTE posibilități

UNA SOLA batteria ricaricabile
MOLTE possibilità

Energy+ rendszer

Az **Energy+ rendszer** egy közös akkumulátorra épülő termékcsalád. Ezen elvnek köszönhetően lehetőségünk van teljesen az egyéni igényeinkhez igazodó gép szortimentet felépíteni a számunkra szükséges mennyiségű akkumulátorral.

System Energy+

System Energy+ este o nouă linie de produse alimentate de acumulatori de același tip. Datorită acestei soluții, există posibilitatea oricărei configurări a setului de produse și alegerea cantității optime de acumulatori necesari.

Sistema Energy+

Il **sistema Energy+** è una nuova linea di prodotti alimentati con batterie ricaricabili dello stesso tipo. Grazie a questa soluzione è possibile una qualsiasi configurazione del set di prodotti e la scelta della quantità ottimale di batterie necessarie.

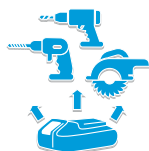

**KOMPATIBILIS
COMPATIBIL
COMPATIBILITÀ**

a kínálatban szereplő összes gép ugyanazzal az akkumulátorral működik

posibilitatea de a utiliza aceiași acumulatori cu diferite tipuri de scule electrice

possibilità di utilizzare la stessa batteria ricaricabile con diversi tipi di elettrodomestici



**MOBIL
MOBIL
MOBILITÀ**

a kábelhossz nem korlátozza a gép használhatóságát

cablul electric nu delimitază utilizarea dispozitivului

utilizzo del dispositivo non limitato dal cavo di alimentazione



**HATÉKONY
EFICIENT
EFFICIENZA**

az akkumulátor bármikor tölthető a kapacitás csökkenés veszélye nélkül

posibilitatea încărcării acumulatorului în orice moment fără riscul de a pierde din capacitatea acestuia

possibilità di ricaricare la batteria in qualsiasi momento, senza il rischio di perdere la sua capacità



**TARTÓS
REZISTENT
DUREVOLEZZA**

kimagasló minőségű anyagok és strapabíró alkatrészek

materiale de înaltă calitate și componente durabile

materiali di alta qualità e componenti durevoli



**KÉNYELMES
MUNKAVÉGZÉS
CONFORTUL MUNCII
COMFORT DI LAVORO**

az ergonomikus kialakításnak és a modern formatervezésnek köszönhetően

asigurat de o construcție ergonomică și un design modern

assicurato grazie alla struttura ergonomica e al design moderno

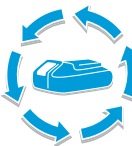

**SOKOLDALÚ
UNIVERSAL
UNIVERSALITÀ**

szabadon és könnyedén variálhatóak a gépek és akkumulátorok

flexibilitate și ușurință în conectarea sculei electrice cu acumulator

flessibilità e facilità di abbinamento dell'elettrodomestico alla batteria ricaricabile



SZÉNKEFE NÉLKÜLI MOTOROKKAL KÉSZÜLT GÉPEK ELŐNYEI:

- ▶ nagyobb teljesítmény kompaktabb, rövidebb szerkezetben
- ▶ maximális forgatónyomaték már minimális fordulatszámon
- ▶ a motor sebességének precíz, elektronikus vezérlése
- ▶ a munkasebességet terhelés alatt is fenntartja

AVANTAJELE DISPOZITIVELOR CU MOTOARE FĂRĂ PERII:

- ▶ mai multă putere într-un design mai compact, construcție mai scurtă
- ▶ cuplu maxim încă de la turații minime
- ▶ control electronic precis al turației motorului
- ▶ menținerea vitezei de funcționare chiar și sub sarcină

VANTAGGI DEI DISPOSITIVI CON MOTORI BRUSHLESS:

- ▶ maggiore potenza in una struttura design più compatta e più corta
- ▶ coppia massima ai giri minimi
- ▶ controllo preciso ed elettronico della velocità del motore
- ▶ mantenimento della velocità di funzionamento anche sotto carico

GRAPHITE

BRUSHLESS



Szénkefe nélküli motor
Motor fără perii
Motore senza spazzole

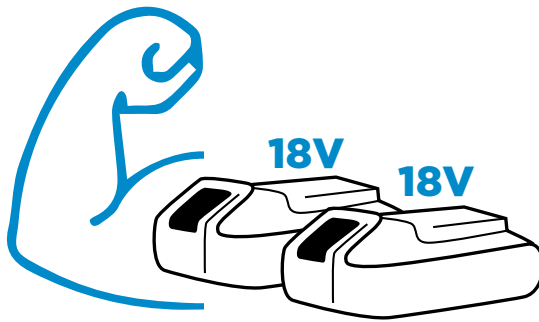

ENERGY+ 36V SYSTEM



- ▶ hálózatról működtetett készülékek teljesítménye az akkumulátoros készülékek mobilitásának megőrzése mellett
- ▶ kompatibilis az Energy+ 18V akkumulátorokkal
- ▶ lehetőség a készülék súlyának megváltoztatására a megfelelő kapacitású akkumulátor kiválasztásával
- ▶ puterea dispozitivelor de rețea prin menținerea mobilității dispozitivelor cu acumulator
- ▶ compatibilitate cu acumulatoroarele Energy + 18V
- ▶ capacitatea de a regla greutatea dispozitivului prin alegerea capacității corespunzătoare a bateriei
- ▶ potenza dei dispositivi di rete mantenendo la mobilità dei dispositivi a batteria
- ▶ compatibilità con le batterie Energy+ 18V
- ▶ possibilità di regolare il peso del dispositivo scegliendo la capacità della batteria appropriata

Fűró-csavarozó
Maşină de găurit şi înşurubat
Trapano-avvitatore

Ref. 58G000

18V
Li-ion

Tokmány méret
 Interval al mandrinei
 Apertura max del mandrino
10 mm

Egykezes tokmány
 Mandrină cu o singură bucă
 Mandrino autoserrante

LED világítás
 Iluminare LED
 Illuminazione LED

Fordulatszám szabályozás
 Controlul vitezei de turajie
 Regolazione della velocità

Gumírozott, ergonomikus markolat
 Mâner ergonomic acoperit cu gumă
 Impugnatura gommata, ergonomica

Övre akasztható
 Cârlig pentru curea
 Clip per cintura

Két sebesség
 Două viteze
 Due velocità
I: 0-350 min⁻¹
II: 0-1250 min⁻¹

Forgatónyomaték
 Moment de torsiune
 Coppia di serraggio
28/44 Nm



Két mechanikus sebességfokozat
 Două viteze mecanice
 Due marce meccaniche



Világítás
 Iluminare
 Illuminazione



NÉVLEGES ADATOK	CARACTERISTICI	DATI NOMINALI	
akkumulátorfeszültség	tensiunea electrica a bateriei	tensione della batteria ricaricabile	18V DC
üresjáratú fordulatszám pterjedelem	intervalul de viteză la mers în gol	velocità a vuoto	0-350 min ⁻¹ 0-1250 min ⁻¹
gyorsbefogó tokmány terjedelme	intervalul mânerului de fixare rapidă	gamma di regolazione del mandrino autoserrante	0,8-10 mm
forgatónyomaték szabályozás terjedelme	intervalul de reglare a momentului de torsiune	gamma di regolazione della coppia	1 – 19 + drilling
max. forgatónyomaték („puha” csavarozás)	momentul de rotație maxim (înşurubare moale)	coppia max (avvitamento morbido)	28 Nm
max. forgatónyomaték („kemény” csavarozás)	momentul de rotație maxim (înşurubare dură)	coppia max (avvitamento duro)	44 Nm
tömege	masa	peso	1.05 kg
EAN	EAN	EAN	5902062035288



EGY akkumulátor
SZÁMOS lehetőség

UN acumulator
MAI MULTE posibilități

UNA SOLA batteria ricaricabile
MOLTE possibilità



HATÉKONY / EFICIENT / EFFICIENZA



216x



428x



Fúró-csavarozó Mașină de găurit și înșurubat Trapano-avvitatore

Ref. 58G022

18V Li-ion



Gyorstokmány
Schimbare rapidă a mânerului
Maniglia a cambio rapido



Kialakított hely a bitek számára
Slot pentru biți
Portainserti per bit



Világítás
Iluminare
Illuminazione

Gyorstokmány
Schimbare rapidă a mânerului
Maniglia a cambio rapido

Kialakított hely a bitek számára
Slot pentru biți
Portainserti per bit

LED világítás
Iluminare LED
Illuminazione LED

Fordulatszám szabályozás
Controlul vitezei de turajie
Regolazione della velocità

Gumírozott, ergonomikus
markolat
Mâner ergonomic acoperit
cu gumă
Impugnatura
gommata, ergonomica

Övre akasztható
Cârlig pentru curea
Clip per cintura

Két sebesség
Două viteze
Due velocità

I: 0-350 min⁻¹
II: 0-1250 min⁻¹

Forgatónyomaték
Moment de torsiune
Coppia di serraggio
28/44 Nm

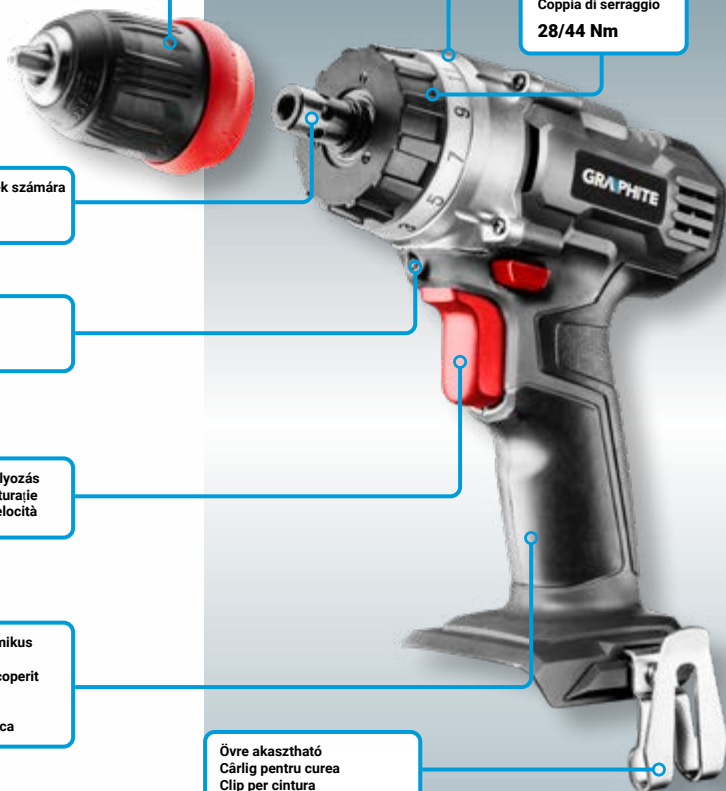

NÉVLEGES ADATOK	CARACTERISTICI	DATI NOMINALI	
akkumulátorfeszültség	tensiunea electrică a bateriei	tensione della batteria ricaricabile	18V DC
üresjáratú fordulatszám pterjedelem	intervalul de viteză la mers în gol	velocitate a vuoto	0-350 min ⁻¹ 0-1250 min ⁻¹
gyorsbefogó tokmány terjedelme	intervalul mânerului de fixare rapidă	gamma di regolazione del mandrino autoserrante	0,8-10 mm
forgatónyomaték szabályozás terjedelme	intervalul de reglare a momentului de torsiune	gamma di regolazione della coppia	1 - 19 + drilling
max. forgatónyomaték („puha” csavarozás)	momentul de rotație maxim (înșurubare moale)	coppia max (avvitamento morbido)	28 Nm
max. forgatónyomaték („kemény” csavarozás)	momentul de rotație maxim (înșurubare dură)	coppia max (avvitamento duro)	44 Nm
tömege	masa	peso	1.1 kg
EAN	EAN	EAN	5902062045973



EGY akkumulátor
SZÁMOS lehetőség

UN acumulator
MAI MULTE posibilități

UNA SOLA batteria ricaricabile
MOLTE possibilità



HATÉKONY / EFICIENT / EFFICIENZA



Fúró-csavarozó
Mașină de găurit și înșurubat
Trapano-avvitatore

Ref. 58G006

18V
Li-ion

Tokmány méret
Interval al mandrinei
Apertura max del mandrino
13 mm

Egykezes tokmány
Mandrînă cu o singură bucăș
Mandrino autoserrante

LED világítás
Iluminare LED
Illuminazione LED

Fordulatszám szabályozás
Controlul vitezei de turație
Regolazione della velocità

Gumírozott, ergonomikus
markolat
Mâner ergonomic acoperit
cu gumă
Impugnatura gommata,
ergonomica

Övre akasztható
Cârlig pentru curea
Clip per cintura

Két sebesség
Două viteze
Due velocità
I: 0-350 min⁻¹
II: 0-1250 min⁻¹

Forgatónyomaték
Moment de torsiune
Coppia di serraggio
35/55 Nm



NÉVLEGES ADATOK	CARACTERISTICI	DATI NOMINALI	
akkumulátorfeszültség	tensiunea electrica a bateriei	tensione della batteria ricaricabile	18V DC
üresjáratú fordulatszám pterjedelem	intervalul de viteză la mers în gol	velocità a vuoto	0-350 min ⁻¹ 0-1250 min ⁻¹
gyorsbefogó tokmány terjedelme	intervalul mânerului de fixare rapidă	gamma di regolazione del mandrino autoserrante	2-13 mm
forgatónyomaték szabályozás terjedelme	intervalul de reglare a momentului de torsiune	gamma di regolazione della coppia	1 – 19 + drilling
max. forgatónyomaték („puha” csavarozás)	momentul de rotație maxim (înșurubare moale)	coppia max (avvitamento morbido)	35 Nm
max. forgatónyomaték („kemény” csavarozás)	momentul de rotație maxim (înșurubare dură)	coppia max (avvitamento duro)	55 Nm
tömege	masa	peso	1.3 kg
EAN	EAN	EAN	5902062035349



EGY akkumulátor
SZÁMOS lehetőség

UN acumulator
MAI MULTE posibilități

UNA SOLA batteria ricaricabile
MOLTE possibilità



HATÉKONY / EFICIENT / EFFICIENZA



2.0Ah



251x



6x60mm



4.0Ah



498x



6x60mm

GRAPHITE

ENERGY+
system



3
YEARS
WARRANTY

Fúró-csavarozó
Mașină de găurit și înșurubat
Trapano-avvitatore

Ref. 58G019

18V
Li-ion

Ütési frekvencia
 Frecvența impacturilor
 Frecvenza d'impatto
I: 0-500 min⁻¹
II: 0-1700 min⁻¹

Forgatónyomaték
 Moment de torsiune
 Coppia di serraggio
38/58 Nm

Tokmány méret
 Interval al mandrinei
 Apertura max del mandrino
2-13 mm

Egyorsós fémtokmány
 Măner metalic cu o singură
 mâncă
 Mandrino di metallo a singola
 ghiera

Fordulatszám szabályozás
 Controlul vitezei de rotație
 Regolazione della velocità

Gumírozott, ergonomikus
 markolat
 Măner ergonomic acoperit
 cu gumă
 Impugnatura gommata,
 ergonomica

LED világítás
 Iluminare LED
 Illuminazione LED

Övre akasztható
 Cărlig pentru curea
 Clip per cintura



Szénkefe nélküli motor
 Motor fără peri
 Motore senza spazzole



Két mechanikus
 sebességfokozat
 Două viteze mecanice
 Due marce meccaniche



Magas forgatónyomaték
 Mare moment de rotație
 Alta coppia motrice

NÉVLEGES ADATOK	CARACTERISTICI	DATI NOMINALI	
akkumulátorfeszültség	tensiunea electrica a bateriei	tensione della batteria ricaricabile	18V DC
üresjárati fordulatszám terjedelelem	intervalul de viteză la mers în gol	velocità a vuoto	0-500 min ⁻¹ 0-1700 min ⁻¹
gyorsbefogó tokmány terjedelme	intervalul mânerului de fixare rapidă	gamma di regolazione del mandrino autoserrante	2-13 mm
forgatónyomaték szabályozás terjedelme	intervalul de reglare a momentului de torsiune	gamma di regolazione della coppia	1 – 16 + drilling
max. forgatónyomaték („puha” csavarozás)	momentul de rotație maxim (înșurubare moale)	coppia max (avvitamento morbido)	38 Nm
max. forgatónyomaték („kemény” csavarozás)	momentul de rotație maxim (înșurubare dură)	coppia max (avvitamento duro)	58 Nm
tömege	masa	peso	1.2 kg
EAN	EAN	EAN	5902062045942



EGY akkumulátor
SZÁMOS lehetőség

UN acumulator
MAI MULTE posibilități

UNA SOLA batteria ricaricabile
MOLTE possibilità



HATÉKONY / EFICIENT / EFFICIENZA



2.0Ah



262x



6x60mm



4.0Ah



519x



6x60mm

GRAPHITE
BRUSHLESS

GRAPHITE

ENERGY+
system



3
YEARS
WARRANTY

Ütvefűró

Maşină de găurit și înşurubat cu percuşii
Trapano-avvitatore a percussione

Ref. 58G010

18V

Li-ion

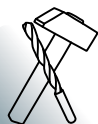

Ütvefűrés
Găurire cu percuşie
Foratura a percussione



Két mechanikus
sebességfokozat
Două viteze mecanice
Due marce meccaniche



Magas forgatónyomaték
Mare moment de rotaţie
Alta coppia motrice

Tokmány méret
Interval al mandrinei
Apertura max del mandrino
13 mm

Ütvefűrés
Găurire cu percuşie
Foratura a percussione
**I: 0-5250 min⁻¹
II: 0-18750 min⁻¹**

Egykezes fém tokmány
Mandrină din metal cu
singură bucă
Mandrino autoserrante
metallico

LED világítás
Iluminare LED
Illuminazione LED

Fordulatszám szabályozás
Controlul vitezei de turajie
Regolazione della velocità

Gumírozott, ergonomikus
markolat
Măner ergonomic acoperit
cu gumă
Impugnatura gommata,
ergonomica

Két sebesség
Două viteze
Due velocità
**I: 0-350 min⁻¹
II: 0-1250 min⁻¹**

Forgatónyomaték
Moment de torsiune
Coppia di serraggio
35/55 Nm

Övre akasztható
Cârlig pentru curea
Clip per cintura

NÉVLEGES ADATOK	CARACTERISTICI	DATI NOMINALI	
akkumulátorfeszültség	tensiunea electrica a bateriei	tensione della batteria ricaricabile	18V DC
üresjárati fordulatszám terjedeleme	intervalul de viteză la mers în gol	velocità a vuoto	0-350 min ⁻¹ 0-1250 min ⁻¹
üresjárati ütvefűrés sebessége	intervalul de percuşii la mers în gol	frequenza della percussione al minimo	0-5250 min ⁻¹ 0-18750 min ⁻¹
gyorsbefűró tokmány terjedelme	intervalul mânerului de fixare rapidă	gamma di regolazione del mandrino autoserrante	2-13 mm
forgatónyomaték szabályozás terjedelme	intervalul de reglare a momentului de torsiune	gamma di regolazione della coppia	1 – 16 + drilling + impact drilling
max. forgatónyomaték („puha” csavarozás)	momentul de rotaţie maxim (înşurubare moale)	coppia max (avvitamento morbido)	35 Nm
max. forgatónyomaték („kemény” csavarozás)	momentul de rotaţie maxim (înşurubare dură)	coppia max (avvitamento duro)	55 Nm
tömege	masa	peso	1.3 kg
EAN	EAN	EAN	5902062035387



EGY akkumulátor
SZÁMOS lehetőség

UN acumulator
MAI MULTE posibilități

UNA SOLA batteria ricaricabile
MOLTE possibilità



HATÉKONY / EFICIENT / EFFICIENZA



221x



439x



Útvefűró

Mašinà de gàurit și înșurubat cu percuții Trapano-avvitatore a percussione

Ref. 58G020

18V Li-ion



Szénkefe nélküli motor
Motor fără peri
Motore senza spazzole



Útvefűrés
Gàurire cu percuție
Foratura a percussione



Két mechanikus
sebességfokozat
Două viteze mecanice
Due marce meccaniche



Magas forgatónyomaték
Mare moment de rotație
Alta coppia motrice

Útvefűrés
Gàurire cu percuție
Foratura a percussione
I: 0-7500 min⁻¹
II: 0-25500 min⁻¹

Tokmány méret
Interval al mandrinei
Apertura max del mandrino
2-13 mm

Egykezes fém tokmány
Mandrină din metal cu o
singură bucsă
Mandrino autoserrante
metallico

Fordulatszám szabályozás
Controlul vitezei de turajie
Regolazione della velocità

Gumírozott, ergonomikus
markolat
Mâner ergonomic acoperit
cu gumă
Impugnatura gommata,
ergonomica

LED világítás
Iluminare LED
Illuminazione LED

Övre akasztható
Cârlig pentru curea
Clip per cintura

Két sebesség
Două viteze
Due velocità
I: 0-500 min⁻¹
II: 0-1700 min⁻¹

Forgatónyomaték
Moment de torsiune
Coppia di serraggio
38/58 Nm

NÉVLEGES ADATOK	CARACTERISTICI	DATI NOMINALI	
akkumulátorfeszültség	tensiunea electrica a bateriei	tensione della batteria ricaricabile	18V DC
üresjáratú fordulatszám perjelelem	intervalul de viteză la mers în gol	velocità a vuoto	0-500 min ⁻¹ 0-1700 min ⁻¹
üresjáratú útvefűrés sebessége	intervalul de percuții la mers în gol	frequenza della percussione al minimo	0-7500 min ⁻¹ 0-25500 min ⁻¹
gyorsbefogó tokmány terjedelme	intervalul mânerului de fixare rapidă	gamma di regolazione del mandrino autoserrante	2-13 mm
forgatónyomaték szabályozás terjedelme	intervalul de reglare a momentului de torsiune	gamma di regolazione della coppia	1 – 16 + drilling + impact drilling
max. forgatónyomaték („puha” csavarozás)	momentul de rotație maxim (înșurubare moale)	coppia max (avvitamento morbido)	38 Nm
max. forgatónyomaték („kemény” csavarozás)	momentul de rotație maxim (înșurubare dură)	coppia max (avvitamento duro)	58 Nm
tömeg	masă	peso	1.2 kg
EAN	EAN	EAN	5902062045959





HATÉKONY / EFFICIENT / EFFICIENZA



2.0Ah



244x



6x60mm



4.0Ah



483x



6x60mm

GRAPHITE
BRUSHLESS

GRAPHITE

ENERGY+
system



3
YEARS
WARRANTY

Útvecsavarozó
Mașină de înșurubat
Avvitatore ad impulsi

Ref. 58G012

18V
Li-ion

Fordulatszám
 Turație
 Velocità
0-2200 min⁻¹

Befogás
 Mandrină
 Mandrino da
1/4" (6,35 mm)

LED világítás
 Iluminare LED
 Illuminazione LED

Jobb -bal irányú forgás
 Turație la dreapta și la stângă
 Rotazione a destra e sinistra

Fordulatszám szabályozás
 Controlul vitezei de turație
 Regolazione della velocità

Gumírozott, ergonomikus
 markolat
 Mâner ergonomic acoperit
 cu gumă
 Impugnatura gommata,
 ergonomica

Övre akasztható
 Cărlig pentru curea
 Clip per cintura



Magas
 Forgatónyomaték
 Mare moment de
 rotație
 Alta coppia motrice



Világítás
 Iluminare
 Illuminazione

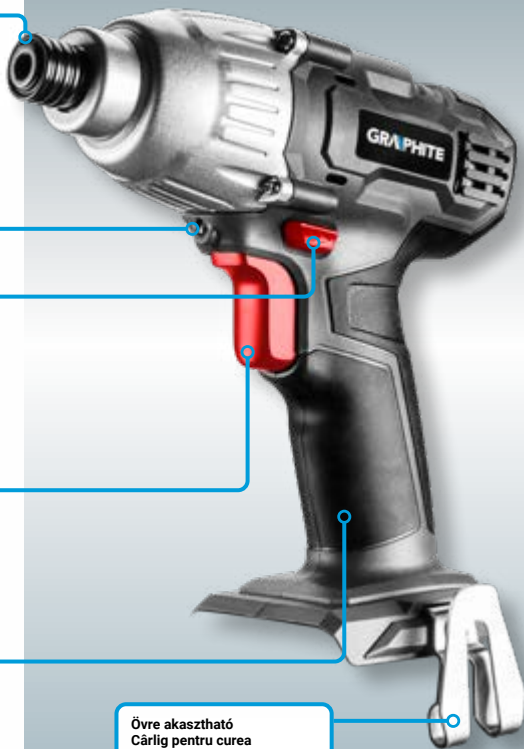

NÉVLEGES ADATOK	CARACTERISTICI	DATI NOMINALI	
akkumulátorfeszültség	tensiunea electrica a bateriei	tensione della batteria ricaricabile	18V DC
üresjáratú fordulatszám pterjedelem	intervalul de viteze la mers în gol	velocità a vuoto	0-2200 min ⁻¹
szerszámbefogó	mandrina	mandrino	6,35 mm (1/4")
maximális forgatónyomaték	max. moment de torsiune	coppia max.	180 Nm
tömege	masa	peso	1.2 kg
EAN	EAN	EAN	5902062035400



EGY akkumulátor
SZÁMOS lehetőség

UN acumulator
MAI MULTE posibilități

UNA SOLA batteria ricaricabile
MOLTE possibilità



HATÉKONY / EFICIENT / EFFICIENZA



2.0Ah



168x



6x60mm



4.0Ah



332x



6x60mm

GRAPHITE

ENERGY+
system



3
YEARS
WARRANTY

Ütvecsavarozó
Mașină de înșurubat
Avvitatore ad impulsi

Ref. 58G024

18V
Li-ion



Színkefe nélküli motor
 Motor fără perii
 Motore senza spazzole



Magas forgatónyomaték
 Mare moment de rotație
 Alta coppia motrice



Világítás
 Iluminare
 Illuminazione

Befogás
 Mandrină
 Mandrino da
 1/4" (6,35 mm)

Jobb -bal irányú forgás
 Turație la dreapta și la stângă
 Rotazione a destra e sinistra

Fordulatszám szabályozás
 Controlul vitezei de turație
 Regolazione della velocità

LED világítás
 Iluminare LED
 Illuminazione LED

Gumírozott, ergonomikus markolat
 Mâner ergonomic acoperit cu gumă
 Impugnatura gommata, ergonomica

Övre akasztható
 Cârlig pentru curea
 Clip per cintura



NÉVLEGES ADATOK	CARACTERISTICI	DATI NOMINALI	
akkumulátorfeszültség	tensiunea electrica a bateriei	tensione della batteria ricaricabile	18V DC
üresjáratú fordulatszám terjedelem	intervalul de viteză la mers în gol	velocità a vuoto	I. 0-1000 min ⁻¹ II. 0-1800 min ⁻¹ III. 0-2700 min ⁻¹
üresjáratú ütvefúrás sebessége	intervalul de percuzii la mers în gol	frequenza della percussione al pminimo	I. 0-1400 min ⁻¹ II. 0-2520 min ⁻¹ III. 0-3780 min ⁻¹
szerszámbefogó	mandrina	mandrino	6,35 mm (1/4")
maximális forgatónyomaték	max. moment de torsiune	coppia max.	80/120/200 Nm
tömege	masa	peso	1.1 kg
EAN	EAN	EAN	5902062059765



GRAPHITE
BRUSHLESS

GRAPHITE

ENERGY+
system 

3
YEARS
WARRANTY

Akkumulátoros ütvecsavarozó
Cheie de impact cu acumulator
Avvitatore a batteria

Ref. 58G018

18V
Li-ion



Magas forgatónyomaték
 Mare moment de rotație
 Alta coppia motrice



Világítás
 Iluminare
 Illuminazione

Befogás
Mandrină
Mandrino da
1/2"

LED világítás
Iluminare LED
Illuminazione LED

Jobb -bal irányú forgás
Turație la dreapta și la stânga
Rotazione a destra e sinistra

Fordulatszám szabályozás
Controlul vitezei de turație
Regolazione della velocità

Gumírozott, ergonomikus markolat
Mâner ergonomic acoperit cu gumă
Impugnatura gommata, ergonomica

Övre akasztható
Cârlig pentru curea
Clip per cintura

Forgatónyomaték
Moment de torsiune
Coppia di serraggio
180 Nm

Fordulatszám
Turație
Velocità
0-2200 min⁻¹



NÉVLEGES ADATOK	CARACTERISTICI	DATI NOMINALI	
akkumulátorfeszültség	tensiunea electrica a bateriei	tensione della batteria ricaricabile	18V DC
üresjáratú fordulatszám terjedelelem	intervalul de viteză la mers în gol	velocità a vuoto	0-2200 min ⁻¹
szerszámbe fogó	mandrina	mandrino	1/2"
max. forgatónyomaték („kemény” csavarozás)	momentul de rotație maxim (înșurubare dură)	coppia max (avvitamento duro)	180 Nm
tömege	masa	peso	1.8 kg
EAN	EAN	EAN	5902062045935



EGY akkumulátor
SZÁMOS lehetőség

UN acumulator
MAI MULTE posibilități

UNA SOLA batteria ricaricabile
MOLTE possibilità



HATÉKONY / EFICIENT / EFFICIENZA

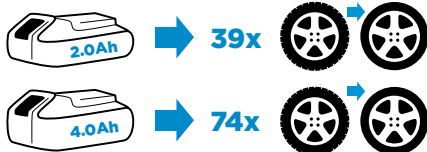

Fúrókalapács
Ciocan rotopercutor
Martello perforatore

Ref. 58G009

18V
Li-ion

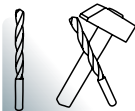

Kétfunkciós
Bifunctional
A due funzioni

Befogás
Mandrină
Mandrino da
SDS-Plus click

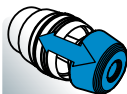

szerszámbefogó
SDS+
mandrina SDS+
mandrino SDS+

LED világítás
Iluminare LED
Illuminazione LED



„Click” szerszámbefogó
Sistem de fixare
burghior ”click”
Sistema di fissaggio
a scatto

Ütvefúrás
Găuire cu percujie
Foratura a percussione
0-5000 min⁻¹

Fordulatszám szabályozás
Control vitezei de turajie
Regolazione della velocità



Világítás
Iluminare
Illuminazione

Gumírozott, ergonomikus markolat
Mâner ergonomic acoperit cu gumă
Impugnatura gommata, ergonomica

Ütési energia
Puterea percujilor
Energia di percussione
0.8 J

Fordulatszám
Turajie
Velocità
0-900 min⁻¹



NÉVLEGES ADATOK	CARACTERISTICI	DATI NOMINALI	
akkumulátorfeszültség	tensiunea electrica a bateriei	tensione della batteria ricaricabile	18V DC
fordulatszám	viteza de turajie	velocità di rotazione	0-900 min ⁻¹
ütvefúrás sebessége	interval percujie	frequenza di percussione	0-5000 min ⁻¹
ütési energia	energia percujiei	energia di percussione	0,8 J
szerszámbefogó	mandrina	mandrino	SDS-Plus
érintésvédelmi osztály	clasa de protecție	classe di isolamento	III
tömege	masa	peso	1.21 kg
EAN	EAN	EAN	5902062035370



EGY akkumulátor
SZÁMOS lehetőség

UN acumulator
MAI MULTE posibilități

UNA SOLA batteria ricaricabile
MOLTE possibilità



HATÉKONY / EFICIENT / EFFICIENZA



➔ **32x**



B20



➔ **63x**



B20



Fúrókalapács
Ciocan rotopercutor
Martello perforatore

Ref. 58G027

18V
Li-ion



Szárkfeje nélküli motor
 Motor fără perii
 Motore senza spazzole



4 funkciók
 Cu patru funcții
 Quattro funzioni

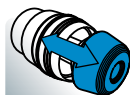

Uchwyłt SDS+
 SDS+ chuck
 Наркоп SDS+



„Click” szerszámefogás
 Sistem de fixarea
 burghior „click”
 Sistema di fissaggio
 a scatto



Világítás
 Iluminare
 Illuminazione

Befogás
Mandrină
Mandrino da
SDS-Plus click

Ütvefűrés
Găuire cu percúție
Foratura a percussione
0-4500 min⁻¹

LED világítás
Iluminare LED
Illuminazione LED

Fordulatszám szabályozás
Controlul vitezei de turajie
Regolazione della velocità

Gumírozott, ergonomikus
markolat
Măner ergonomic acoperit
cu gumă
Impugnatura gommata,
ergonomica

Ütési energia
Puterea percúțiilor
Energia di percussione
2.2 J

Fordulatszám
Turajie
Velocità
0-1420 min⁻¹



NÉVLEGES ADATOK	CARACTERISTICI	DATI NOMINALI	
akkumulátorfeszültség	tensiunea electrica a bateriei	tensione della batteria ricaricabile	18V DC
fordulatszám	viteza de turajie	velocità di rotazione	0-1420 min ⁻¹
ütvefűrés sebessége	interval percúție	frequenza di percussione	0-4500 min ⁻¹
ütési energia	energia percúției	energia di percussione	2.2 J
szerszámefogó	mandrina	mandrino	SDS-Plus
maximális furatátmérő: fa/acél/beton	diametrul maxim de foraj: lemn/otel/beton	diametro massimo di perforazione: legno/acciaio/calcestruzzo	28/13/22 mm
érintésvédelmi osztály	clasa de protecție	classe di isolamento	III
tömege	masa	peso	2.1 kg
EAN	EAN	EAN	5902062059789



EGY akkumulátor
SZÁMOS lehetőség

UN acumulator
MAI MULTE posibilități

UNA SOLA batteria ricaricabile
MOLTE possibilità



GRAPHITE
BRUSHLESS

GRAPHITE

ENERGY+
system



3
YEARS
WARRANTY

Sarokcsiszoló
Polizor unghiular
Smergliatrice angolare

Ref. 58G003

18V
Li-ion



Keskeny ház
Carcasa îngusta
Corpo compatto



A fogantyú két irányban
szerezhető
Montarea manerului în
două feluri
Impugnatura montabilă
de entranbii i lateri



Orsó retesz
Blocadă a axului
Bloccaggio dell'alberino

Biztonsági kapcsoló
Comutator sigur
Interruttore di sicurezza

Fordulatszám
Turajie
Velocità
10000 min⁻¹

Szerszámmentes védőburkolat állítás
Reglarea capacului de protecție fără
folosirea vreunei scule
Protezione regolabile senza utensili

Tárcsa átmérője
Diametrul discului
Diametro del disco
115 mm

Vékony gumírozott,
ergonomikus markolat
Măner ergonomic, acoperit
cu gumă
Sottile impugnatura
ergonomica in gomma

NÉVLEGES ADATOK	CĂRACTERISTICI	DATI NOMINALI	
akkumulátorfeszültség	tensiunea electrică a bateriei	tensione della batteria ricaricabile	18V DC
fordulatszám	viteza de turajie	velocità di rotazione	10000 min ⁻¹
vágókorong max. átmérő	diametru max. al discului	diametro max disco	115 mm
vágókorong belső átmérő	diametru interior al discului	diametro interno del disco	22,2 mm
orsó menet	filet al axului	filetto dell'alberino	M14
érintésvédelmi osztály	clasa de protecție	classe di isolamento	III
tömege	masa	peso	1,5 kg
EAN	EAN	EAN	5902062035318





HATÉKONY / EFICIENT / EFFICIENZA



37x

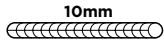

10mm



72x

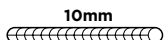

10mm



**Sarokcsiszoló
Polizor unghiular
Smerigliatrice angolare**

Ref. 58G026

**18V
Li-ion**



Szénkefe nélküli motor
Motor fără peri
Motore senza spazzole



Keskeny ház
Carcasa îngusta
Corpo compatto



A fogantyú két
irányban szerelhető
Montarea mânerului în
două direcții
Impugnatura montabile
da entrambi i lati



Orsó retesz
Blocadă a axului
Bloccaggio dell'alberino

Biztonsági kapcsoló
Comutator sigur
Interruttore di sicurezza

Fordulatszám
Turajie
Velocità
10000 min⁻¹

Szerszámmentes védőburkolat
állítás
Reglarea capacului de protecție fărâ
folosirea vreunei scule
Protezione regolabile senza utensili

Tárcsa átmérője
Diametrul discului
Diametro del disco
125 mm

Vékony gumírozott,
ergonomikus markolat
Mâner ergonomic, acoperit
cu gumă
Sottile impugnatura
ergonomica in gomma

NÉVLEGES ADATOK	CARACTERISTICI	DATI NOMINALI	
akkumulátorfeszültség	tensiunea electrica a bateriei	tensione della batteria ricaricabile	18V DC
fordulatszám	viteza de turajie	velocità di rotazione	10000 min ⁻¹
vágókörong max. átmérő	diametru max. al discului	diametro max disco	125 mm
vágókörong belső átmérő	diametru interior al discului	diametro interno del disco	22,2 mm
orsó menet	filet al axului	filetto dell'alberino	M14
érintésvédelmi osztály	clasa de protecție	classe di isolamento	III
tömege	masa	peso	1,7 kg
EAN	EAN	EAN	5902062059772





GRAPHITE
BRUSHLESS

GRAPHITE

ENERGY+
system



3
YEARS
WARRANTY

Akkumulátoros multifunkciós gép
Dispositiv multifuncțional cu acumulator
Dispositivo multifunzione a batteria

Ref. 58G013

18V
Li-ion

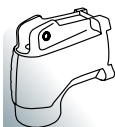

Aluminiu test
 Corp din aluminiu
 Corpo in alluminio



Gyors csere
 Fixare rapidă
 Attacco rapido

A tartozékok cseréje nem igényel
 szerszámot
 Instalare a accesoriilor fără scule
 Installazione di accessori senza attrezzi

Vékony gumírozott,
 ergonomikus markolat
 Mâner ergonomic, acoperit
 cu gumă
 Sottile impugnatura
 ergonomica in gomma

Szabályozható sebesség
 Reglarea vitei
 Controllo della velocità
5000-20000 min⁻¹



2 x LED Világítás
 2 x Iluminare LED
 2 x illuminazione a LED

Porszívó-csatlakozó
 Conexiunile pentru aspirator
 Collegamento all'aspirapolvere

Rezgési szög
 Unghi de oscilare
 Angolo di oscillazione
3°

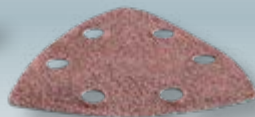
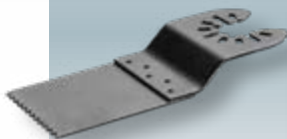

NÉVLEGES ADATOK	CARACTERISTICI	DATI NOMINALI	
akkumulátorfeszültség	tensiunea electrica a bateriei	tensione della batteria ricaricabile	18V DC
rezgésszám	număr de oscilații	tasso di oscillazione	5000-20000 min ⁻¹
tömege	masa	peso	1.8 kg
rezgési szög	unghi de oscilare	angolo di oscillazione	3°
EAN	EAN	EAN	5902062035417



EGY akkumulátor
SZÁMOS lehetőség

UN acumulator
MAI MULTE posibilități

UNA SOLA batteria ricaricabile
MOLTE possibilità



HATÉKONY / EFICIENT / EFFICIENZA



340x



20x20 mm

19min



590x



20x20 mm

33min



Excentersziszoló
Șlefuitor cu excentric
Levigatrice rotoorbitale

Ref. 58G014

18V
Li-ion

Fordulatszám
Turajie
Velocità
5000/7000/9000 min⁻¹

Gumírozott, ergonomikus markolat
Măner ergonomic acoperit cu gumă
Impugnatura gommata, ergonomica

Porzsák
Sac pentru praf
Sacchetto raccogli-polvere

Oscillálás amplitúdó
Amplitudinea oscilării
Diametro di oscillazione
2.7 mm



Tépfóráras (papír-) rögzítés
 Fixarea hârtiei abrazive
 Fissaggio (della carta)
 con velcro



Poreltszívó rendszer
 Sistem de aspirarea
 prafului
 Sistema di aspirazione
 della polvere



NÉVLEGES ADATOK	CARACTERISTICI	DATI NOMINALI	
akkumulátorfeszültség	tensiunea electrica a bateriei	tensione della batteria ricaricabile	18V DC
üresjáratú fordulatszám-terjedelem	intervalul de viteză la mers în gol	диапазон частоты вращения на холостом ходу	5000/7000/9000 min ⁻¹
üresjáratú oszcilláció-terjedelem	interval de oscilare în mers gol	gamma di oscillazione a vuoto	10000/14000/18000 min ⁻¹
oszcillálás amplitúdó	amplitudine de oscilare	diametro di oscillazione	2,7 mm
a csiszolótalp méretei	dimensiunile tălii / hârtiei abrazive	dimensioni del platorello / carta abrasiva	125 mm
érintésvédelmi osztály	clasa de protecție	classe di isolamento	III
tömege	masa	peso	1.14 kg
EAN	EAN	EAN	5902062035424





HATÉKONY / EFICIENT / EFFICIENZA



➔ 28 min



➔ 55 min



Dekopírfűrész
Ferăstrău pendular
Seghetto alternativo

Ref. 58G011

18V
Li-ion



Aluminiu asztal
Bază de aluminiu
Base in alluminio



Világítás
Iluminare
Illuminazione



Lengőfűrész üzemmód
Funcție pendulară
de tăiere
Funzione di taglio



T típusú fűrészlap
Lamă de tăiere tip T
Attacco Lame di tipo T

Fa / Fém
Lemn / Metal
Legno / Metallo
80 / 10 mm

Löketszám
Număr de cicluri
Numero di cicli
0-2400 min⁻¹

LED világítás
Iluminare LED
Illuminazione LED

3 oszcillációs tartomány
3 trepte de oscilare
3 gamme di oscillazione

Fűrészlap előtolás
Mișcarea lamei de tăiere
Corsa della lama
25 mm

Alumínium talp
Talpă din aluminiu
Piedino in alluminio

Gumírozott, ergonomikus markolat
Mâner ergonomic acoperit cu gumă
Impugnatura gommata, ergonomica

Porszívó csatlakozás
Conectarea la aspirator
Raccordo per l'aspirapolvere



NÉVLEGES ADATOK	CARACTERISTICI	DATI NOMINALI	
akkumulátorfeszültség	tensiunea electrica a bateriei	tensione della batteria ricaricabile	18V DC
löketszám (üresjárásban)	număr de curse de mers (in mers gol)	numero di corse della lama (a vuoto)	0-2400 min ⁻¹
lökethossz	lungimea cursei de mers	corsa della lama	25 mm
érintésvédelmi osztály	clasa de protecție	classe di isolamento	III
tömege	masa	peso	1.7 kg
EAN	EAN	EAN	5902062035394





HATÉKONY / EFICIENT / EFFICIENZA



10 m



16 mm



20 m



16 mm



Akkumulátoros orrfűrész
Fierăstrău sabie cu acumulator
Sega a gattuccio a batteria

Ref. 58G017

18V
Li-ion

Vékony gumírozott,
 ergonomikus markolat
 Mâner ergonomic, acoperit
 cu gumă
 Sottile impugnatura
 ergonomica in gomma

A fűrészlap cseréje nem igényel
 szerszámot
 Instalare fărã scule a pânzei
 Installazione della lama senza attrezzi

A talp helyzete állítható
 Reglarea poziției piciorului
 Regolazione della posizione del piede

Löketszám
 Număr de cicluri
 Numero di cicli
0-3000 min⁻¹

Állítható sebesség
 Reglare lină a turărilor
 Regolazione continua
 della velocità

A fűrészlap két pozícióban szerelhető fel
 Două poziții de montare a pânzei
 Due posizioni di installazione della lama

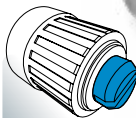

A fűrészlap cseréje nem
 igényel szerszámot
 Instalare fărã scule
 a pânzei
 Installazione della lama
 senza attrezzi



Állítható sebesség
 Reglare lină a turărilor
 Regolazione continua
 della velocità

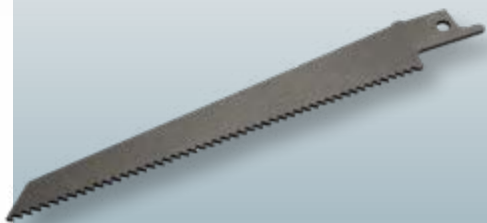
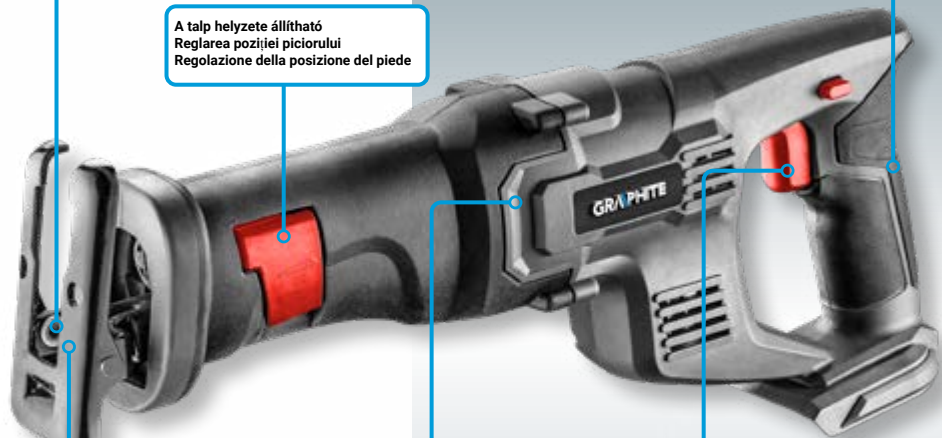

NÉVLEGES ADATOK	CARACTERISTICI	DATI NOMINALI	
akkumulátorfeszültség	tensiunea electrica a bateriei	tensione della batteria ricaricabile	18V DC
sebesség	turării	giri	0-3000 min ⁻¹
Fűrészlap lökete	săritură pânză	passo della lama	22 mm
vágott anyag maximális vastagsága: fa fém	Grosimea maximă a materialului tăiat: lemn metal	spessore massimo del materiale tagliato: legno metallo	60 mm 6 mm
tömege	masa	peso	1.8 kg
EAN	EAN	EAN	5902062035928



HATÉKONY / EFICIENT / EFFICIENZA



164x

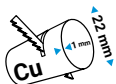

313x

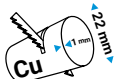

GRAPHITE

ENERGY+
system



3
YEARS
WARRANTY

Körfűrész
Ferăstrău pendular
Sega circolare

Ref. 58G008

18V
Li-ion

Ferdevágási tartomány
Interval de tăiere înclinată
Regolazione dell'angolo di taglio
inclinato - verticale
0-45°

Gumirozott, ergonomikus markolat
Măner ergonomic acoperit cu gumă
Impugnatura gommata, ergonomica

Fordulatszám
Turajle
Velocità
4200 min⁻¹

Porszívó csatlakozás
Conectarea la aspirator
Raccordo per l'aspirapolvere

Lézeres vonalvezetés
Afișier cu laser
Puntatore laser

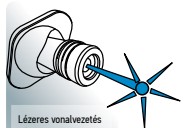

Lézeres vonalvezetés
Afișier cu laser
Puntatore laser



Állítható vágásszög
Unghiul de tăiere
ajustabil
Angolo di taglio
regolabile

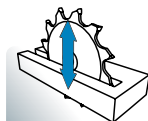

Szabályozott
vágásmélység
Ajustarea adâncimii
de tăiere
Regolazione della
profondità di taglio



Max. vágásmélység
Adâncimea max. de tăiere
Profondità max di taglio
48 mm

Párhuzam vezetésű
Muncă cu ghidaj paralel
Funzionamento con guida parallela

Fűrészlap
Disc de tăiere
Disco
150 mm / 10 mm

NÉVLEGES ADATOK	CARACTERISTICI	DATI NOMINALI	
akkumulátorfeszültség	tensiunea electrica a bateriei	tensione della batteria ricaricabile	18V DC
fordulatszám	viteza de turajle	velocità di rotazione	4200 min ⁻¹
ferdevágási tartomány	Interval de tăiere înclinată	gamma di taglio inclinato	0° - 45°
vágókorong max. átmérő	diametru max. al discului	макс. диаметр диска	150 mm
vágókorong belső átmérő	diametru interior al discului	диаметр отверстия диска	10 mm
max. pvágásmélység 90° szög alatt	adâncimea de tăiere max la unghi 90°	profundità max di taglio ad un angolo di 90°	48 mm
max. pvágásmélység 45° szög alatt	adâncimea de tăiere max la unghi 45°	profundità max di taglio ad un angolo di 45°	36 mm
tömege	masa	peso	2.48 kg
EAN	EAN	EAN	5902062035363





HATÉKONY / EFICIENT / EFFICIENZA



23 m



16 mm



45 m



16 mm



Körfűrész
Ferăstrău pendular
Sega circolare

Ref. 58G023

18V
Li-ion



Szénkefe nélküli motor
 Motor fără peri
 Motore senza spazzole

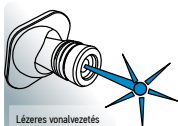

Lézeres vonalvezetés
 Afișier cu laser
 Puntatore laser



Állítható vágásszög
 Unghiul de tăiere
 ajustabil
 Angolo di taglio
 regolabile

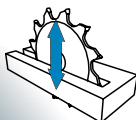

Szabályozott
 vágásmélység
 Ajustarea adâncimii
 de tăiere
 Regolazione della
 profondità di taglio

Gumírozott, ergonomikus markolat
 Mâner ergonomic acoperit cu gumă
 Impugnatura gommata, ergonomica

Porszívó csatlakozás
 Conectarea la aspirator
 Raccordo per l'aspirapolvere

Ferdevágási tartomány
 Interval de tăiere înclinată
 Regolazione dell'angolo di taglio
 inclinato - verticale
0-45°

Fordulatszám
 Turajie
 Velocità
0-4200 min⁻¹

Lézeres vonalvezetés
 Afișier cu laser
 Puntatore laser



Max. vágásmélység
 Adâncimea max. de tăiere
 Profondità max di taglio
52 mm

Párhuzam vezetésin
 Muncă cu ghidaj paralel
 Funzionamento con guida parallela

Fűrészlap
 Disc de tăiere
 Disco
165 mm / 20 mm

NÉVLEGES ADATOK	CARACTERISTICI	DATI NOMINALI	
akkumulátorfeszültség	tensiunea electrica a bateriei	tensione della batteria ricaricabile	18V DC
fordulatszám	viteza de turajie	velocità di rotazione	0-4200 min ⁻¹
ferdevágási tartomány	Interval de tăiere înclinată	gamma di taglio inclinato	0° ÷ 45°
vágókorong max. átmérő	diametru max. al discului	макс. диаметр диска	165 mm
vágókorong belső átmérő	diametru interior al discului	диаметр отверстия диска	20 mm
max. pvágásmélység 90° szög alatt	adâncimea de tăiere max la unghi 90°	profundità max di taglio ad un angolo di 90°	52 mm
max. pvágásmélység 45° szög alatt	adâncimea de tăiere max la unghi 45°	profundità max di taglio ad un angolo di 45°	35 mm
tömege	masa	peso	2.95 kg
EAN	EAN	EAN	5907558480061





GRAPHITE
BRUSHLESS

GRAPHITE

ENERGY+
system



3
YEARS
WARRANTY

Akkumulátoros kompresszor kiegészítőkkal
Compresor cu acumulator cu accesorii
Compressore a batteria con accessori

Ref. 58GO41

18V
Li-ion



Elektronikus vezérlés
 Control electronic
 Controllo elettronico



Világítás
 Illuminare
 Illuminazione

Gumirozott fogantyú
 Mâner cauciucat
 Impugnatura gommata

LED világítás
 Illuminare LED
 Illuminazione LED

Elektronikus vezérlés
 Control electronic
 Controllo elettronico



NÉVLEGES ADATOK	CARACTERISTICI	DATI NOMINALI	
akkumulátorfeszültség	tensiunea electrica a bateriei	tensione della batteria ricaricabile	18V DC
fordulatszám	viteza de turajie	velocità di rotazione	21000 min ⁻¹
max. nyomás:	presiune maximă	pressione massima	100 psi (7 bar)
tömege	masa	peso	0.8 kg
EAN	EAN	EAN	5907558480085



EGY akkumulátor
SZÁMOS lehetőség

UN acumulator
MAI MULTE posibilități

UNA SOLA batteria ricaricabile
MOLTE possibilità



HATÉKONY / EFICIENT / EFFICIENZA



2.0Ah

➔ 27 min



4.0Ah

➔ 55 min



Akkumulátoros ragasztópisztoly
Pistol pentru adeziv cu acumulator
Pistola per colla a batteria

Ref. 58G040

18V
Li-ion

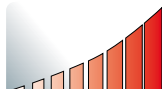

Gyors indítás
 Start rapid
 Avvio rapido

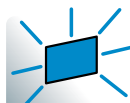

Töltöttség jelző
 Indicator de control al
 alimentării
 Spia di alimentazione

Gyors indítás
 Start rapid
 Avvio rapido

Gumírozott fogantyú
 Mâner cauciucat
 Impugnatura gommata

Töltöttség jelző
 Indicator de control al alimentării
 Spia di alimentazione

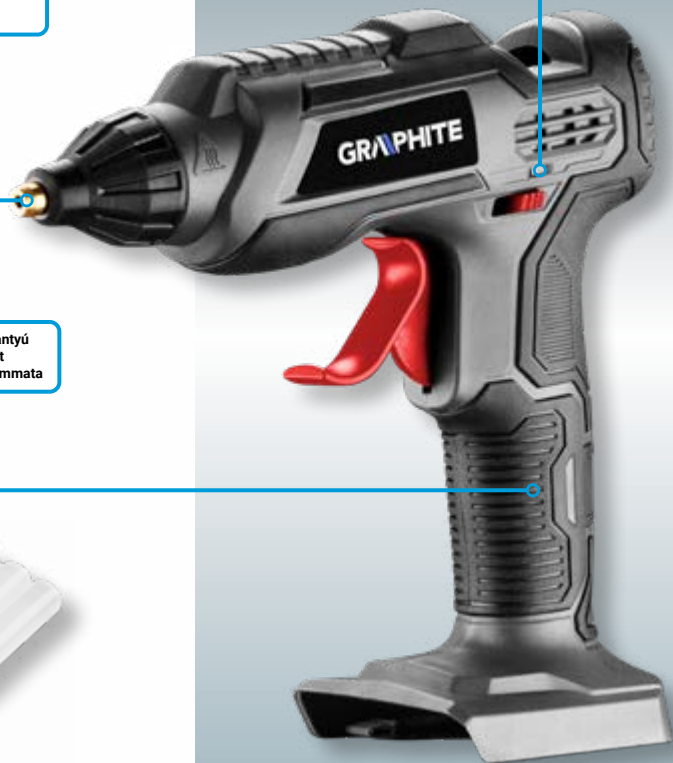

NÉVLEGES ADATOK	CARACTERISTICI	DATI NOMINALI	
akkumulátorfeszültség	tensiunea electrica a bateriei	tensione della batteria ricaricabile	18V DC
ragasztó patron átmérője:	Diametrul cartuşului de adeziv	diametro dell'inserto adesivo	11 mm
fűtőelem hőmérséklete	temperatura elementului de încălzire	temperatura dell'elemento riscaldante	160°C±210°C
felhűtési idő	timpul de încălzire	tempo di riscaldamento	3 min
teljesítmény	randament	efficienza	8 g/min
tömege	masa	peso	0.4 kg
EAN	EAN	EAN	5907558480078



EGY akkumulátor
SZÁMOS lehetőség

UN acumulator
MAI MULTE posibilități

UNA SOLA batteria ricaricabile
MOLTE possibilità



HATÉKONY / EFICIENT / EFFICIENZA



2.0Ah

➔ 116 min



4.0Ah

➔ 243 min



Lámpa
Lanternă
Torcia elettrica

Ref. 58G007

18V
Li-ion



Munkaszög
szabályozás
Ajustarea unghiului
de lucru
Regolazione
dell'angolo di lavoro

Fényerő
Fluxul de lumină
Intensità Flusso luminoso
260 lm

Színhőmérséklet
Temperatura culorilor
Tonalità della luce
7000K

Sugárzási szög
Unghiul de iluminare
Angolo di illuminazione
120°

Gumírozott, ergonomikus
markolat
Mâner ergonomic acoperit
cu gumă
Impugnatura gommata,
ergonomica

5-pozíciós fej
Cap cu 5 poziții
Testa a 5 posizioni

Teljesítmény
Putere
Potenza
3W



Övre akasztható
Cârlig pentru curea
Clip per cintura

NÉVLEGES ADATOK	CARACTERISTICI	DATI NOMINALI	
akkumulátorfeszültség	tensiunea electrică a bateriei	tensione della batteria ricaricabile	18V DC
teljesítmény	putere	potenza	3 W
diódák száma	număr de leduri	numero di LED	3
fényerő	flux luminos	flusso luminoso	260 lm
színhőmérséklet	temperatura de culoare	temperatura di colore	7000 K
sugárzási szög	unghi de iluminare	angolo di illuminazione	120°
tömege	masa	peso	0.26 kg
EAN	EAN	EAN	5902062035356





HATÉKONY / EFICIENT / EFFICIENZA



GRAPHITE

ENERGY+
system



3
YEARS
WARRANTY

USB adaptert - LED k zil mpa
Adaptor USB - lantern  LED
Adattatore USB - torcia a LED

Ref. 58G025

18V
Li-ion



USB
POWER BANK

 vre akaszthat 
C rlig pentru curea
Clip per cintura

Vil gítás
Illuminare
Illuminazione



USB powerbank
Funcția de inc rcarea dispozitivelor externe
Funzione di ricarica del dispositivo esterno

N�VLEGES ADATOK	CARACTERISTICI	DATI NOMINALI	
akkumul�torfesz�lts�g	tensiunea electrica a bateriei	tensione della batteria ricaricabile	18V DC
teljesitm�ny	putere	potenza	1 W
di�d�k s�z�ma	num�r de leduri	numero di LED	1
k�ls� USB kimenetek	ie�iri externe USB	uscite esterne USB	5V DC 1,5A
t�mege	masa	peso	0,11 kg
EAN	EAN	EAN	5907558480092





HATÉKONY / EFICIENT / EFFICIENZA



➔ **7200 mAh**
25 h



➔ **14400 mAh**
50 h



Akkumulátoros fűkasza
Trimmer de gazon cu acumulator
Tagliabordi a batteria

Ref. 58G030

18V
Li-ion



Kiegészítő 3D markolat
 Măner suplimentar 3D
 Maniglia 3D supplementare



Állítható fej
 Cap reglabil
 Testa regolabile

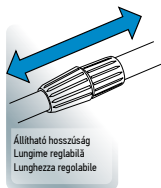

Ergonomikus kapcsoló
 Comutator ergonomic
 Interruttore ergonomico

Állítható hosszúság
 Lungime reglabilă
 Lunghezza regolabile

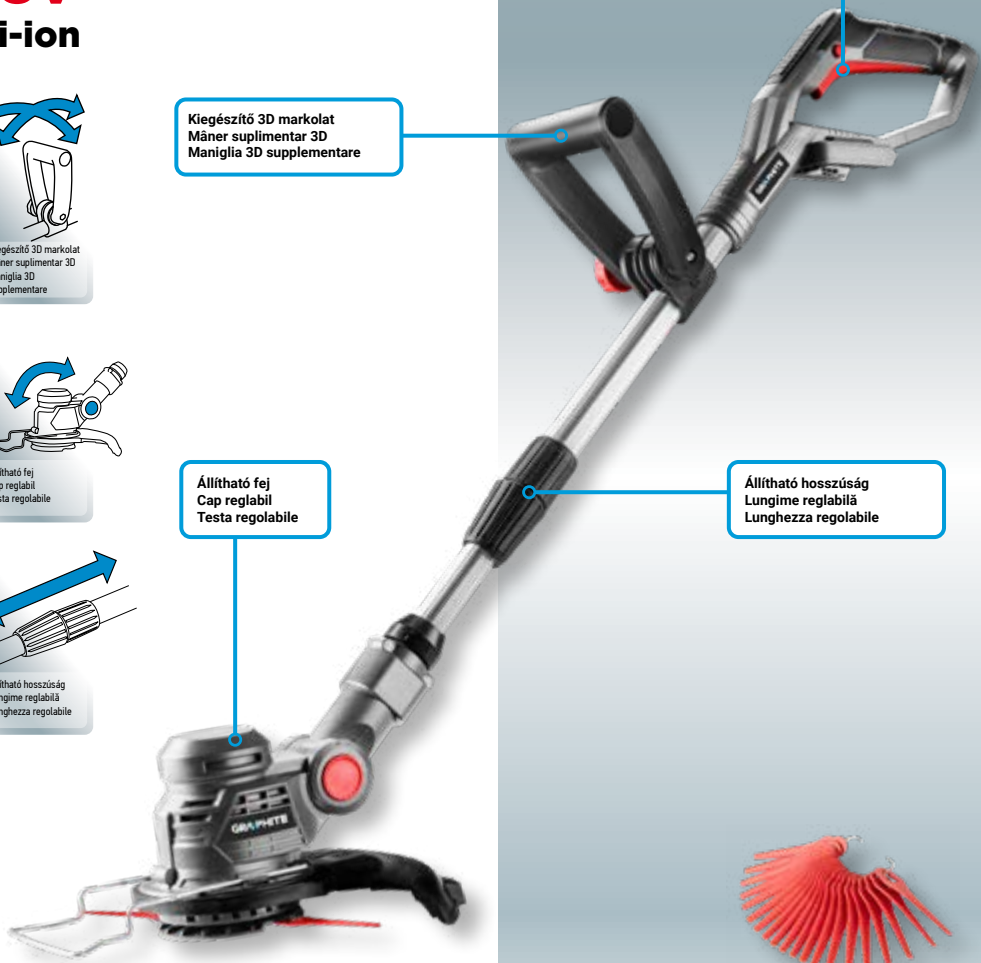

K/58G030-30

NÉVLEGES ADATOK	CARACTERISTICI	DATI NOMINALI	
akkumulátorfeszültség	tensiunea electrica a bateriei	tensione della batteria ricaricabile	18V DC
fordulatszám	viteza de turajie	velocità di rotazione	9000 min ⁻¹
vágási szélesség	lățimea de tăiere	larghezza di taglio	254 mm
a nyél hossza állítható	reglarea lungimii mânerului	regolazione della lunghezza della maniglia	1.1-1.4 m
polimer kések	cuțite de polimer	lame polimeriche	88.5 mm
tömege	masa	peso	1.8 kg
EAN	EAN	EAN	5902062057655



EGY akkumulátor
SZÁMOS lehetőség

UN acumulator
MAI MULTE posibilități

UNA SOLA batteria ricaricabile
MOLTE possibilità



HATÉKONY / EFICIENT / EFFICIENZA



2.0Ah

➔ 32 min



4.0Ah

➔ 60 min



Akkumulátoros sövényvágó
Foarfece pentru gard viu cu acumulator
Tagliasiepi a batteria

Ref. 58G032

18V
Li-ion



Kézvédő
 Protecție pentru palme
 Protezione delle mani



Forgatható markolat
 Măner rotativ
 Maniglia girevole



Ergonomikus kapcsoló
 Comutator ergonomic
 Interruttore ergonomico

Forgatható markolat
 Măner rotativ
 Maniglia girevole

Kézvédő
 Protecție pentru palme
 Protezione delle mani

Ergonomikus kapcsoló
 Comutator ergonomic
 Interruttore ergonomico

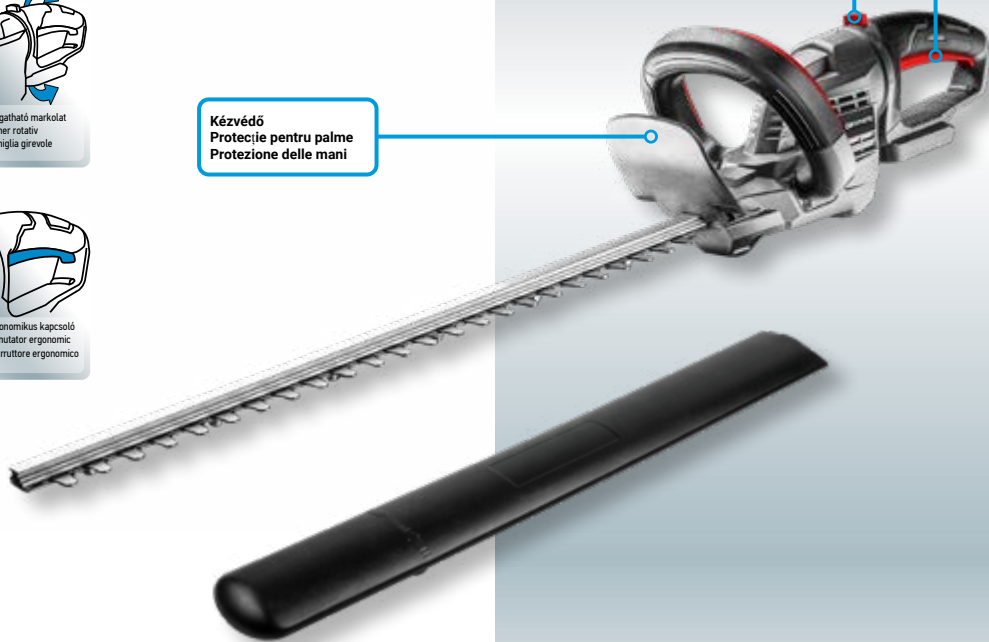

NÉVLEGES ADATOK	CARACTERISTICI	DATI NOMINALI	
akkumulátorfeszültség	tensiunea electrica a bateriei	tensione della batteria ricaricabile	18V DC
penge sebessége üresjárásban	Viteza lamei fără sarcină	velocità della lama senza carico	1300 min ⁻¹
vágási szélesség	lățime de tăiere	larghezza di taglio	510 mm
vágóél hossza	lung. benzii de tăiere	lunghezza della lama	570 mm
max. vágási vastagság	grosimea max. de tăiere	larghezza di taglio massima	15 mm
tömege	masa	peso	2.2 kg
EAN	EAN	EAN	5902062057662





HATÉKONY / EFICIENT / EFFICIENZA



➔ 71 min



➔ 140 min



Akkumulátoros lombfúvó
Suflantă cu acumulator
Soffiatore a batteria

Ref. 58G031

18V
Li-ion



Ergonomikus fogantyú
Mâner ergonomic
Impugnatura ergonomica



Könnyen szállítható
Transport ușor
Trasportazione facile

Könnyen szállítható
Transport ușor
Trasportazione facile

Ergonomikus fogantyú
Mâner ergonomic
Impugnatura ergonomica

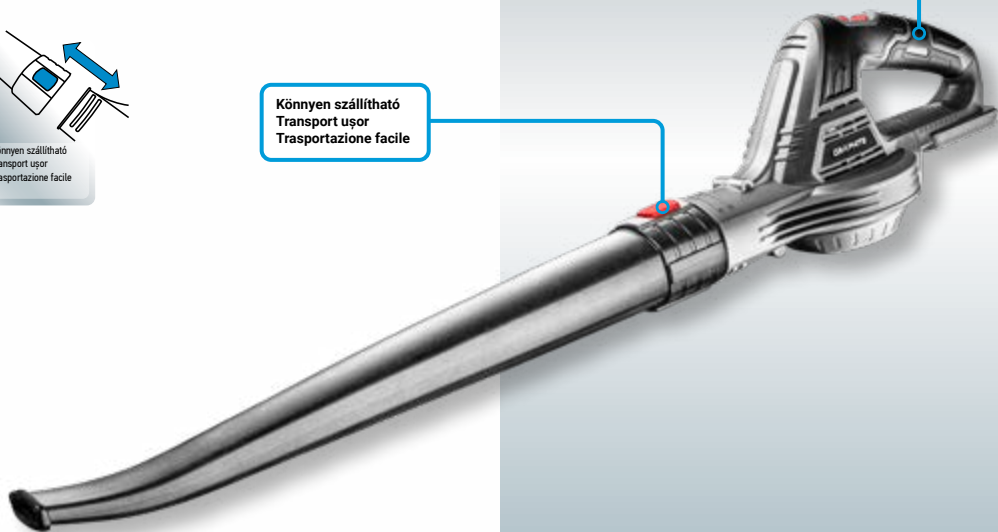

NÉVLEGES ADATOK	CARACTERISTICI	DATI NOMINALI	
akkumulátorfeszültség	tensiunea electrica a bateriei	tensione della batteria ricaricabile	18V DC
sebesség	turații	giri	12000 min ⁻¹
légáramlás sebessége	viteza fluxului de aer	velocità del flusso d'aria	190 km/h
tömege	masa	peso	1.2 kg
EAN	EAN	EAN	5902062057679





HATÉKONY / EFICIENT / EFFICIENZA



21 min

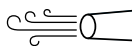

40 min

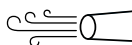

Akkumulátoros sövényvágó
Foarfece pentru gard viu cu acumulator
Tagliasiepi a batteria

Ref. 58GO42

36V
Li-ion

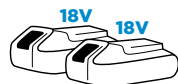

ENERGY+
36V SYSTEM



Kézvédő
 Protecție pentru palme
 Protezione delle mani



Forgatható markolat
 Măner rotativ
 Maniglia girevole



Ergonomikus kapcsoló
 Comutator ergonomic
 Interruttore ergonomico

Forgatható markolat
 Măner rotativ
 Maniglia girevole

Kézvédő
 Protecție pentru palme
 Protezione delle mani

Ergonomikus kapcsoló
 Comutator ergonomic
 Interruttore ergonomico

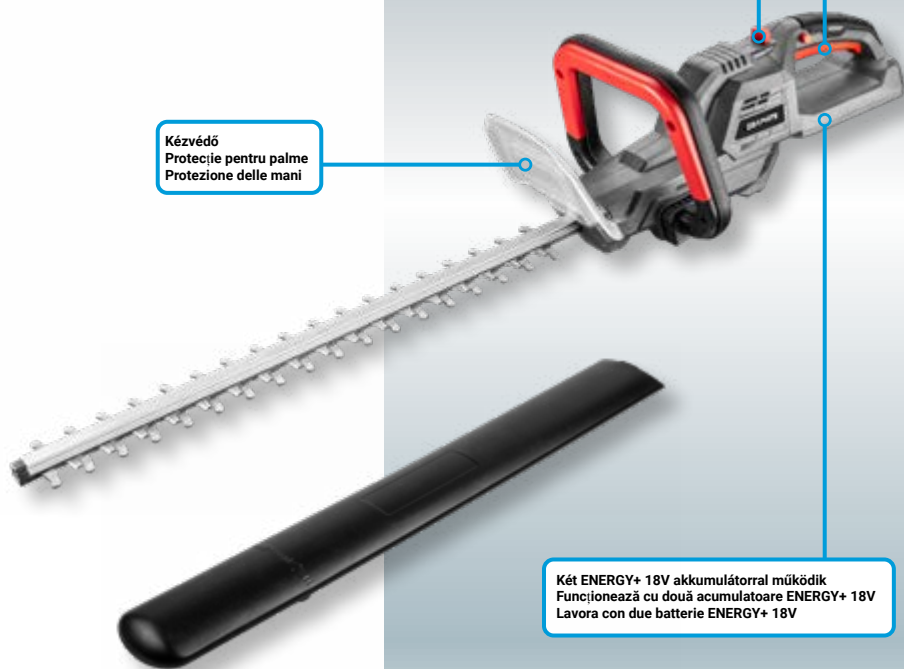

Két ENERGY+ 18V akkumulátorral működik
 Funcționează cu două acumulatori ENERGY+ 18V
 Lavora con due batterie ENERGY+ 18V

NÉVLEGES ADATOK	CARACTERISTICI	DATI NOMINALI	
akkumulátorfeszültség	tensiunea electrica a bateriei	tensione della batteria ricaricabile	36V DC
penge sebessége üresjárásban	Viteza lamei fără sarcină	velocità della lama senza carico	2800 min ⁻¹
vágási szélesség	lățime de tăiere	larghezza di taglio	520 mm
vágóélc hossza	lung. benzii de tăiere	lunghezza della lama	595 mm
max. vágási vastagság	grosimea max. de tăiere	larghezza di taglio massima	20 mm
tömege	masa	peso	3.0 kg
EAN	EAN	EAN	5902062501165



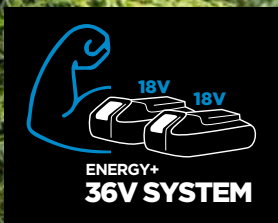

GRAPHITE



Akkumulátoros láncfűrész
Fierăstrău cu lanț cu acumulator
Motosega a catena a batteria

Ref. 58G043

36V

Li-ion

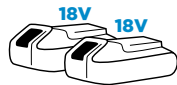

ENERGY+
36V SYSTEM



Szénkefe nélküli motor
 Motor fără peri
 Motore senza spazzole



A láncfeszítés nem igényel szerszámot
 Tensionare a lanțului fără scule
 Tensionamento della catena senza utensili



Ergonómikus fogantyú
 Mâner ergonomic
 Impugnatura ergonomica

Szénkefe nélküli motor
 Motor fără peri
 Motore senza spazzole

A láncfeszítés nem igényel szerszámot
 Tensionare a lanțului fără scule
 Tensionamento della catena senza utensili

Ergonomiczna rekojęć
 Ergonomic handle
 Ergonomичная рукоятка

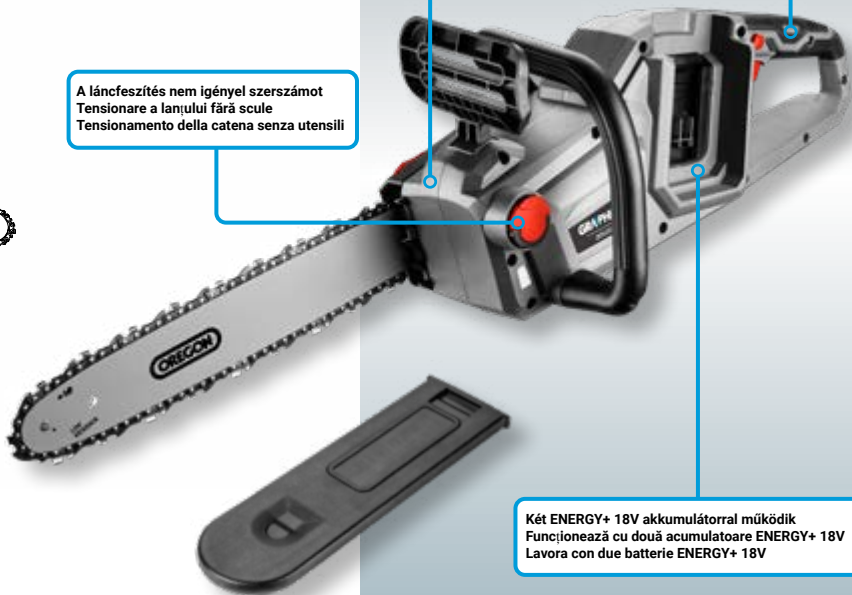

Két ENERGY+ 18V akkumulátorral működik
 Funcționează cu două acumulatori ENERGY+ 18V
 Lavora con due batterie ENERGY+ 18V

NÉVLEGES ADATOK	CARACTERISTICI	DATI NOMINALI	
akkumulátorfeszültség	tensiunea electrică a bateriei	tensione della batteria ricaricabile	36V DC
üresjárati fordulatszám terjedelem	intervalul de viteză la mers în gol	velocità a vuoto	10 000 min ⁻¹
lánchú sebessége terhelés nélkül	turațiile liniare ale lanțului fără sarcină	Velocità lineare del motore senza carico	0 ÷ 19 m/s
olajtartály térfogata	volumul rezervorului de ulei	capacità del serbatoio dell'olio	160 ml
lánckerék (fogszám x osztás)	pinion (dinti x pas)	pignone (denti x passo)	6 x 3/8"
vezetőlécz	ghidaj	guida	14" (350 mm)
lánchosztása	pas cu lanț	passo della catena	3/8" (9,525 mm)
lánchvastagsága	grosimea lanțului	spessore della catena	1,3 mm
tömege	masa	peso	2,8 kg
EAN	EAN	EAN	5902062501172



EGY akkumulátor
SZÁMOS lehetőség

UN acumulator
MAI MULTE posibilități

UNA SOLA batteria ricaricabile
MOLTE possibilità

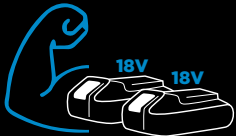

18V 18V
ENERGY+
36V SYSTEM

GRAPHITE
BRUSHLESS

GRAPHITE

ENERGY+
system 

3
YEARS
WARRANTY

Akkumulátoros lombfúvó
Suflantă cu acumulator
Soffiatore a batteria

Ref. 58G044

36V

Li-ion

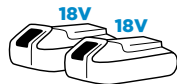

ENERGY+
36V SYSTEM



Ergonomikus fogantyú
Mâner ergonomic
Impugnatura ergonomica

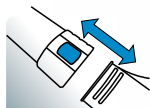

Könnyen szállítható
Transport ușor
Trasportazione facile

Két ENERGY+ 18V akkumulátorral működik
Funcționează cu două acumulatori ENERGY+ 18V
Lavora con due batterie ENERGY+ 18V

Ergonomikus fogantyú
Mâner ergonomic
Impugnatura ergonomica

Könnyen szállítható
Transport ușor
Trasportazione facile

NÉVLEGES ADATOK	CARACTERISTICI	DATI NOMINALI	
akkumulátorfeszültség	tensiunea electrică a bateriei	tensione della batteria ricaricabile	36V DC
sebesség	turații	giri	20000 min ⁻¹
légáramlás sebessége	viteza fluxului de aer	velocità del flusso d'aria	162 km/h
tömege	masa	peso	2.5 kg
EAN	EAN	EAN	5902062501189



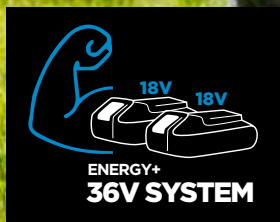

Akkumulátor GRAPHITE ENERGY+
Acumulator GRAPHITE ENERGY+
Accumulatore GRAPHITE ENERGY+

Ref. 58G001

18V
Li-ion

18V / 2.0Ah

Töltétszint jelző
 Indicatorul stării de încărcare
 Indicatore dello stato di carica

Nincs memória effektus
 Fără efect de memorie
 Nessun effetto di memoria

Elektronikus hőmérséklet ellenőrző rendszer
 Sistemul electronic de control al temperaturii
 Sistema di controllo elettronico della temperatura

Áramerősség szabályozó rendszer
 Sistemul de control al fluxului de curent electric
 Sistema di controllo del flusso di corrente



NÉVLEGES ADATOK	CARACTERISTICI	DATI NOMINALI	
akkumulátorfeszültség	tensiunea electrica a bateriei	tensione della batteria ricaricabile	18V DC
akkumulátor típus	tip acumulator	tipo di batteria ricaricabile	Li-Ion
akkumulátor kapacitása	capacitate acumulator	capacità della batteria ricaricabile	2Ah
környezeti hőmérséklet tartomány	temperatura mediului ambiant	gamma di temperature di esercizio	4°C – 40°C
tömege	masa	peso	0.4 kg
EAN	EAN	EAN	5902062035295





Akkumulátor GRAPHITE ENERGY+
Acumulator GRAPHITE ENERGY+
Accumulatore GRAPHITE ENERGY+

Ref. 58G004

18V
Li-ion

18V / 4.0Ah

Nincs memória effektus
 Fără efect de memorie
 Nessun effetto di memoria

Elektronikus hőmérséklet
 ellenőrző rendszer
 Sistemul electronic de control al
 temperaturii
 Sistema di controllo elettronico
 della temperatura



Töltöttségiszint jelző
 Indicatorul stării de încărcare
 Indicatore dello stato di carica

Áramerősség szabályozó rendszer
 Sistemul de control al fluxului de curent
 electric
 Sistema di controllo del flusso di
 corrente

NÉVLEGES ADATOK	CARACTERISTICI	DATI NOMINALI	
akkumulátorfeszültség	tensiunea electrica a bateriei	tensione della batteria ricaricabile	18V DC
akkumulátor típus	tip acumulator	tipo di batteria ricaricabile	Li-Ion
akkumulátor kapacitása	capacitate acumulator	capacità della batteria ricaricabile	4Ah
környezeti hőmérséklet tartomány	temperatura mediului ambiant	gamma di temperature di esercizio	4°C – 40°C
tömege	masa	peso	0.65 kg
EAN	EAN	EAN	5902062035325





Akkumulátor GRAPHITE ENERGY+
Acumulator GRAPHITE ENERGY+
Accumulatore GRAPHITE ENERGY+

Ref. 58G086

18V
Li-ion

18V / 6.0Ah

Nincs memória effektus
Fără efect de memorie
Nessun effetto di memoria

Elektronikus hőmérséklet ellenőrző rendszer
Sistemul electronic de control al temperaturii
Sistema di controllo elettronico della temperatura

Töltöttségiszint jelző
Indicatorul stării de încărcare
Indicatore dello stato di carica



Áramerősség szabályozó rendszer
Sistemul de control al fluxului de curent electric
Sistema di controllo del flusso di corrente

* A 58G086 akkumulátorokat főként a két akkumulátorral táplált készülékekhez ajánljuk, de a többi készüléknél is használhatók. Nagyobb méreteik miatt ezek mechanikailag korlátozhatják a garantált paraméterek elérését és bizonyos felhasználási lehetőségeket ennél a készülékcsoportnál. Itt pl. a körfűrészek max. vágási mélységének a csökkenéséről vagy a készülékre állíthatóan felszerelt kiegészítő elemek használati szöveghez tartozó szükséges változtatásáról van szó – pl. excentercsiszoló porészívója, stb. Ezek a kényelmetlenségek azonban nincsenek hatással a használat biztonságára.

* Akkumulátorek 58G086 sunt dedicate mai ales grupului de dispozitive alimentate de două acumulatori, cu toate acestea, pot fi utilizate și pentru alte dispozitive. Datorită dimensiunilor mari, acestea pot limita mecanic posibilitatea de a realiza parametrii declarați și capacitatea de utilizare a unor dispozitive din acest grup. Este vorba, de exemplu, despre reducerea adâncimii maxime de tăiere a fierăștraielor circulare sau necesitatea modificării unghiului de utilizare a elementelor suplimentare montate pe dispozitiv - de exemplu extragerea prafului unei șlefuitoare excentrice, etc. Aceste inconveniențe nu afectează siguranța utilizării.

* Le batterie 58G086 sono dedicate principalmente al gruppo di dispositivi alimentati da due batterie, ma possono essere utilizzate anche per altri dispositivi. A causa delle loro maggiori dimensioni possono limitare meccanicamente la possibilità di raggiungere i parametri dichiarati e le performance di alcuni dispositivi di questo gruppo. Si tratta, ad esempio, di ridurre la profondità massima di taglio delle seghe circolari o la necessità di modificare l'angolo di utilizzo di elementi aggiuntivi montati sull'apparecchio - ad esempio l'aspirazione della polvere di una smerigliatrice eccentrica, ecc. Tuttavia, questi inconvenienti non influiscono sulla sicurezza d'uso.

NÉVLEGES ADATOK	CARACTERISTICI	DATI NOMINALI	
akkumulátorfeszültség	tensiunea electrica a bateriei	tensione della batteria ricaricabile	18V DC
akkumulátor típus	tip acumulator	tipo di batteria ricaricabile	Li-Ion
akkumulátor kapacitása	capacitate acumulator	capacità della batteria ricaricabile	6Ah
környezeti hőmérséklet tartomány	temperatura mediului ambiant	gamma di temperature di esercizio	4°C – 40°C
tömege	masa	peso	0.95 kg
EAN	EAN	EAN	5902062501158





Akkumulátortöltő GRAPHITE ENERGY+
Incarcator pentru acumuloare GRAPHITE ENERGY+
Caricabatterie GRAPHITE ENERGY+

Ref. 58G002

2.3A

Elektronikus töltés ellenőrző rendszer
 Sistemul electronic de control al încărcării
 Sistema di controllo elettronico della carica

Az akkumulátorokhoz
 Pentru acumulatori
 Per batterie ricaricabili
Energy + 18V

Töltőáram
 Curent de încărcare
 Corrente di carica
2.3A

Jelző dióda
 Bec de semnalizare
 Diodo di segnalazione

Óra
 Pentru
 Per
1h - 58G001
2h - 58G004
3h - 58G086

Kompakt méret
 Dimensiuni compacte
 Dimensioni compatte



NÉVLEGES ADATOK	CARACTERISTICI	DATI NOMINALI	
tápfeszültség	tensiune electrica	tensione di alimentazione	230V AC
hálózati frekvencia	frecventa de alimentare	frequenza di alimentazione	50 Hz
töltőfeszültség	tensiune de încărcare	tensione di carica	22 V DC
max. töltőáram	max. curent electric de încărcare	corrente massima di carica	2.3A
akkumulátor töltési idő	timp de încărcare	tempo di carica	1-3h
környezeti hőmérséklet tartomány	temperatura mediului ambiant	gamma di temperature di esercizio	4°C - 40°C
érintésvédelmi osztály	clasa de protecție	classe di isolamento	II
tömege	masa	peso	0.3 kg
EAN	EAN	EAN	5902062035301



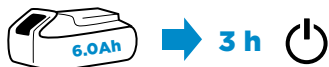
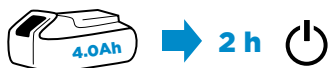

Akkumulátortöltő GRAPHITE ENERGY+
Incarcator pentru acumuloare GRAPHITE ENERGY+
Caricabatterie GRAPHITE ENERGY+

Ref. 58G085

2x 3A

Az akkumulátorokhoz
 Pentru acumulatori
 Per batterie ricaricabili
Energy + 18V

Töltőáram
 Curent de încărcare
 Corrente di carica
3A

Jelző dióda
 Bec de semnalizare
 Diodo di segnalazione

Óra
 Pentru
 Per
45 min - 58G001
90 min - 58G004
135 min - 58G086

Elektronikus töltés ellenőrző
 rendszer
 Sistemul electronic de control al
 încărcării
 Sistema di controllo elettronico
 della carica







Kompakt méret
 Dimensiuni compacte
 Dimensioni compatte



NÉVLEGES ADATOK	CARACTERISTICI	DATI NOMINALI	
tápfeszültség	tensiune electrică	tensione di alimentazione	230V AC
hálózati frekvencia	frecvența de alimentare	frequenza di alimentazione	50 Hz
töltőfeszültség	tensiune de încărcare	tensione di carica	2 x 21,5 V DC
max. töltőáram	max. curent electric de încărcare	corrente massima di carica	3A
környezeti hőmérséklet tartomány	temperatura mediului ambiant	gamma di temperature di esercizio	4°C - 40°C
érintésvédelmi osztály	clasa de protecție	classe di isolamento	II
tömege	masa	peso	0.7 kg
EAN	EAN	EAN	5902062501141





	➔	45 min	
	➔	90 min	
	➔	135 min	

Akciós kezdő készlet

Set: Mașină de găurit și de înșurubat cu acumulator, geantă + lanternă

Set: Trapano avvitatore senza fili, borsa + torcia elettrica

Ref. 58G016

18V Li-ion

Gépszett – praktikus táskával a gépek és kiegészítők kényelmes tárolására.

A készlet tartalma: fúró-csavarozó, lámpa, akkumulátor 2.0Ah, akkútöltő és táska.

Igényes csomagolás.

Set de produse - set gata de utilizare, cu o geantă pentru depozitarea echipamentelor și a accesoriilor.

Setul conține: mașină de găurit și de înșurubat, lanternă, bateria 2.0 Ah, încărcător și geantă.

Întregul set este ambalat într-un ambalaj elegant.

Set di prodotti – set pronto all'uso dotato di pratica borsa per riporre utensili e accessori.

Il set comprende: trapano-avvitatore, torcia elettrica, batteria 2.0 Ah, carica batterie e borsa di trasporto.

Il tutto racchiuso in una confezione dedicata.



58G015



58G007

58G000



58G001



58G002

NÉVLEGES ADATOK	CARACTERISTICI	DATI NOMINALI	
tömege	masa	peso	2 kg
EAN	EAN	EAN	59020620388357

EGY akkumulátor
SZÁMOS lehetőség

UN acumulator
MAI MULTE posibilități

UNA SOLA batteria ricaricabile
MOLTE possibilità



Energy+ készlet alumínium kofferben
Set Energy+ în valiză de aluminiu
Kit Energy+ in una valigetta di alluminio

Ref. 58G000-PS14

18V

Li-ion

Készlet tartalma:

- fúró-csavarozó (58G000)
- két akkumulátor 2.0Ah (58G002)
- töltő (58G001)
- 109 db. tartozék: bitek és fúrók

Funcționalis alumínium koffer kialakított helyvel a készlet minden eleme számára

Bitek nagy keménységű S2 acélból

Componența setului:

- mașină de găurit și înșurubat (58G000)
- două acumuloare 2.0Ah (58G002)
- încărcător (58G001)

- 109 accesorii sub formă de biți și burghie

Valiză funcțională din aluminiu cu loc prevăzut pentru fiecare element al setului

Biți din oțel S2 de duritate înaltă

Composizione del kit:

- trapano/avvitatore (58G000)
- due batterie 2.0Ah (58G002)
- caricabatterie (58G001)

- 109 accessori - bit e punte da trapano

Funzionale valigia in alluminio con spazio per ogni elemento del kit

Bit in acciaio S2 ad alta durezza



NÉVLEGES ADATOK	CARACTERISTICI	DATI NOMINALI	
EAN	EAN	EAN	5902062047823



Energy+ készlet alumínium kofferben
Set Energy+ în valiză de aluminiu
Kit Energy+ in una valigetta di alluminio

Ref. 58G022-PS15

18V

Li-ion

Készlet tartalma:
fűró-csavarozó levehető tokmánnal (ez takarja a bitek hatszögletű fészkrét) (58G022)
- két akkumulátor 2.0Ah (58G001)
- töltő (58G002)
- 109 db. tartozék: bitek és fűrók
Funkcionális alumínium koffer kialakított helyel a készlet minden eleme számára
Bitek nagy keménységű S2 acélból"

Componența setului:
- mașină de găurit și înșurubat cu mâner detașabil (care permite accesul la slotul hexagonal pentru biți) (58G022)
- două acumulatori 2.0Ah (58G001)
- încărcător (58G002)
- 109 accesorii sub formă de biți și burghie
Valiză funcțională din aluminiu cu loc prevăzut pentru fiecare element al setului
Biți din oțel S2 de duritate înaltă

Composizione del kit:
- trapano/avvitatore con impugnatura rimovibile (che espone portainseriti esagonale per i bit) (58G022)
- due batterie 2.0Ah (58G001)
- caricabatterie (58G002)
- 109 accessori - bit e punte da trapano
Funzionale valigia in alluminio con spazio per ogni elemento del kit
Bit in acciaio S2 ad alta durezza



NÉVLEGES ADATOK	CARACTERISTICI	DATI NOMINALI	
EAN	EAN	EAN	5902062058515

EGY akkumulátor
SZÁMOS lehetőség

UN acumulator
MAI MULTE posibilități

UNA SOLA batteria ricaricabile
MOLTE possibilità



Táska
Geanta
Borsa

Ref. 58G015

12L
Poliester

Tartós, belülről laminált anyag
Material durabil, laminat pe
interior
Materiale durevole, laminato
all'interno

3 belső zseb,
9 külső szerszám akasztó
3 buzunare interioare
9 cârligie interne pentru scule
3 tasche interne
9 asole interne per utensilii

14 külső zseb
14 buzunare exterioare
14 tasche esterne

Fém akasztó elektromos szerszámhoz
Cârlig metalic pentru scule electrice
Gancio in metallo per elettroutensilii

Hordozófűl
Măner pentru transport
Maniglia di trasporto

Átlátszó tok a névjegynek
Spațiu pentru etichetă
personalizată
Scoperto per etichetta
personalizzata



Állítható vállpánt
Curea de umăr reglabilă
Tracolla regolabile

NÉVLEGES ADATOK	CARACTERISTICI	DATI NOMINALI	
tömege	masa	peso	0,7 kg
EAN	EAN	EAN	5902062035431



Táska
Geanta
Borsa

Ref. 58G021

24L
Poliester

Hordozófül
Mâner pentru transport
Maniglia di trasporto

Tartós, belülről laminált anyag
Material durabil, laminat pe interior
Materiale durevole, laminato all'interno

5 belső zseb
10 belső szerszámakasztó
5 buzunare interioare,
10 cărlige interne pentru scule
5 tasche interne,
10 ganci interni per utensilii

20 külső zseb
20 buzunare externe
20 tasche esterne

Állítható vállpánt
Curea de umăr reglabilă
Tracolla regolabile

2 fém akasztó a fűrő-csavarozó
számára
2 cărlige metalice pentru mașina
de găurit și înșurubat
2 ganci di metallo per trapano/
avvitatore

Átlátszó tok a névjegynek
Spațiu pentru etichetă
personalizată
Scomparto per etichetta
personalizzata



NÉVLEGES ADATOK	CARACTERISTICI	DATI NOMINALI	
tömege	masa	peso	1.5 kg
EAN	EAN	EAN	5902062045966

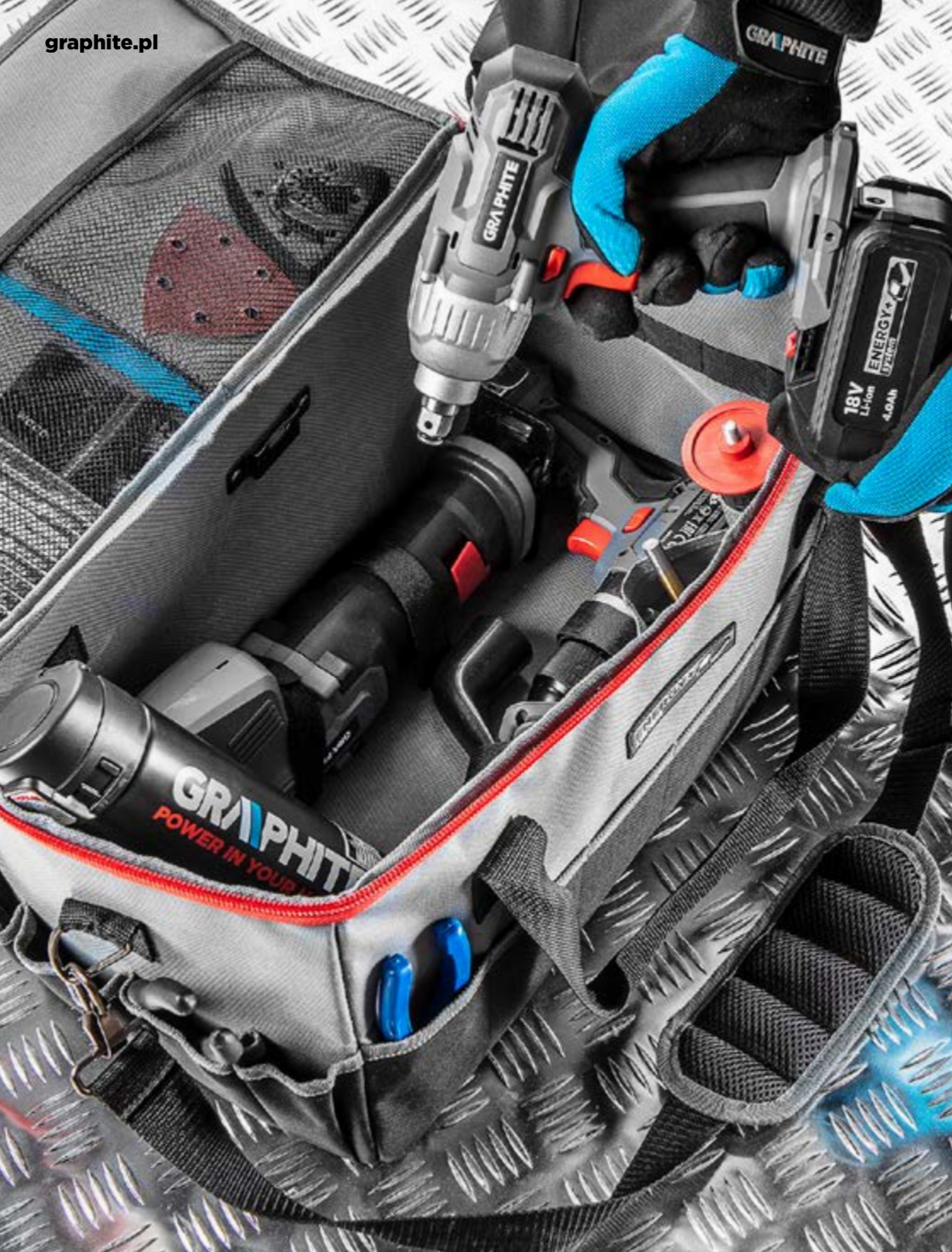



ENERGY+
system



graphite.pl

